



## USER MANUAL

# CultureCoin®

Rev. 10.0  
Revision Date 26/06/2024  
Rx only



 Escos Medical Technologies, UAB  
Gamybos g. 2 • Ramučiai, Kauno r., 54468 Lithuania  
Tel +370 37 470 000  
www.esco-medical.com • support-medical@escolifesciences.com

For Technical Service, contact:

Europe

Esco Medical Technologies, UAB  
Gamybos g. 2 • Ramučiai, Kauno r., 54468 Lithuania  
Tel +370 37 470 000  
www.esco-medical.com • support-medical@escolifesciences.com

North America

Esco Technologies, Inc.  
903 Sheehy Drive, Suite F, Horsham, • PA 19044, USA  
Tel 215-441-9661 • Fax 484-698-7757  
www.escolifesciences.us • eti.admin@escoglobal.com

Rest of the World

Esco Micro Pte. Ltd.  
21 Changi South Street 1 • Singapore 486 777  
Tel +65 6542 0833 • Fax +65 6542 6920  
www.escolifesciences.com • mail@escolifesciences.com

## Copyright Information

© Copyright 2014 Esco Micro Pte Ltd. All rights reserved.

The information in this manual and the accompanying product is copyrighted and all rights are reserved by Esco.

Esco reserves the right to make periodic minor design changes without obligation to notify any person or entity of such change.

Sentinel™ is a registered trademark of Esco.

Caution: Federal law restricts this device to sale by or on a licensed healthcare practitioner's order.

Only to be used by a trained and qualified professional. The device is sold under exemption 21 CFR 801 Subpart D.

*"Material in this manual is provided for informational purposes only. The contents and the product described in this manual (including any appendix, addendum, attachment or inclusion) are subject to change without notice. Esco makes no representations or warranties as to the accuracy of the information contained in this manual. In no event shall Esco be held liable for any damages, direct or consequential, arising out of or related to the use of this manual."*

## **Unpacking and Inspection**

Follow standard receiving practices upon receipt of the medical device. Check the shipping carton for damage. If the damage is found, stop unpacking the medical device. Notify the freight carrier and ask for an agent to be present while the medical device is unpacked. There are no special unpacking instructions, but be careful not to damage the medical device when unpacking it. Inspect the medical device for physical damage such as bent or broken parts, dents, or scratches.

## **Claims**

Our routine method of shipment is via common carrier. If physical damage is found, upon delivery, retain all packing materials in their original condition and immediately contact the carrier to file a claim.

If the medical device is delivered in good physical condition but does not operate within specifications, or if there are any other problems not caused by shipping damage, please contact your local sales representative or Esco Medical Technologies, UAB immediately.

## **Standard Terms and Conditions**

### **Refunds & Credits**

Please note only sterilized products (products labeled with a distinct serial number) and accessories are eligible for a partial refund and/or credit. The *Return Procedure* must be followed.

### **Return Procedure**

Every product returned for refund/credit must be accompanied by a Return Material Authorization (RMA) number, obtained from Esco Medical Technologies, UAB Customer Service. All items being returned must be sent *prepaid* (freight, duty, brokerage and taxes) to our factory location.

### **Restocking Charges**

Products returned within 30 days of original purchase are subject to a minimum restocking fee of 20% of the list price. Additional charges for damage and/or missing parts and accessories will be applied to all returns. Products that are not in “as new” and resalable condition are not eligible for credit return and will be returned to the customer at their own expense.

### **Certification**

This medical device has been thoroughly tested/inspected and found to meet Esco Medical Technologies, UAB manufacturing specifications when shipped from the factory.

### **Warranty and Product Support**

Esco Medical Technologies, UAB warrants this medical device to be free from defects in materials and workmanship under regular use and service until the date “Use by”

provided on the label. During the warranty period, Esco Medical Technologies, UAB will replace a product that proves to be defective at no charge, provided you return the product (shipping, duty, brokerage and taxes prepaid) to Esco Medical Technologies, UAB. Any transportation charges incurred are the purchaser's responsibility and are not included within this warranty. This warranty extends only to the original purchaser. It does not cover damage from abuse, neglect, accident or misuse, or as the result of service or modification by parties other than Esco Medical Technologies, UAB

IN NO EVENT SHALL ESCO MEDICAL TECHNOLOGIES, UAB BE LIABLE FOR CONSEQUENTIAL DAMAGES.

No warranty shall apply when any of the following causes damage:

- Damage in transit or when moving the medical device
- Accident, alteration, abuse or misuse of the medical device
- Fire, water damage, theft, war, riot, hostility, acts of God such as hurricanes, floods, etc.

Only CultureCoin® is covered under this warranty if the package is not damaged during storage and transportation.

PHYSICAL DAMAGE CAUSED BY MISUSE OR PHYSICAL ABUSE IS NOT COVERED UNDER THE WARRANTY.

This warranty gives you specific legal rights and you may have other rights, which vary from province to province, state to state, or country to country. This warranty is limited to repairing the medical device per Esco Medical Technologies, UAB specifications.

When you return the medical device to Esco Medical Technologies, UAB for investigation, we recommend shipment using the original shipping foam and container. If the original packing materials are not available, we recommend the following guide for repackaging:

- Use a double-walled carton of sufficient strength for the weight being shipped. There cannot be spare space in the shipment box with the medical device; otherwise, it will move and can cause possible damage
- In the case of a single medical device is sent, an envelope with an adapted bubble envelope may be used

Esco Medical Technologies, UAB will not be responsible for lost shipments or medical devices received in damaged condition due to improper packaging or handling. All warranty claim shipments must be made on a prepaid basis (freight, duty, brokerage, and taxes). No returns will be accepted without a Return Materials Authorization ("RMA") number. Please contact Esco Medical Technologies, UAB to obtain an RMA number and receive help with shipping/customs documentation.

### **Warranty Disclaimer**

With CultureCoin® dishes could work only individuals with formal education in a relevant field of healthcare or medical discipline. If this medical device is used by other person,

Esco Medical Technologies, UAB takes no responsibility for damage to users, patients and property.

If a primary package of CultureCoin® is damaged before opening it, Esco Medical Technologies, UAB takes no responsibility for damage to users, patients and property.

**WARNING**

Esco Medical Technologies, UAB will not be responsible for any possible injury and side effects sustained due to unauthorized equipment modifications.

ESCO MEDICAL TECHNOLOGIES, UAB DISCLAIMS ALL OTHER WARRANTIES, EXPRESSED OR IMPLIED, INCLUDING ANY WARRANTY OF MERCHANTABILITY OR FITNESS FOR A PARTICULAR PURPOSE OR APPLICATION.

THIS PRODUCT CONTAINS NO USER-SERVICEABLE COMPONENTS.

# Table of contents

1 How to use this manual.....	7
2 Safety warning.....	7
3 Intended purpose/use.....	7
4 About the product.....	7
5 Safety symbols and labels .....	9
6 Important safety instructions and warnings.....	10
6.1 Pre-use .....	10
6.2 During use.....	10
6.3 Post-use .....	11
7 The Culture mode.....	11
8 Overview.....	11
9 Use.....	12
10 CultureCoin® placement in the chamber.....	13
11 Removing the CultureCoin® cover .....	13
12 The use illustrated.....	14
13 pH measuring.....	15
14 Writing area on the CultureCoin® and lid.....	15
15 User troubleshooting.....	16
16 Specifications.....	16
17 Other countries.....	17
17.1 Switzerland.....	17
18 Reporting on serious incidents .....	17

## 1 How to use this manual

The manual is intended to be read from start to finish.

 **Digital version of the English user manual and all available translated versions are available on our website [www.esco-medical.com](http://www.esco-medical.com).**

To locate this user manual, simply follow these steps:

1. Click on the "Products" tab in the navigation menu.
2. Scroll down and select "CultureCoin® - Embryo Culture Dish for the MIRI® TL".
3. Continue scrolling further down to find the "Literature & Resources" section.
4. Click on the "Information for Users" tab.

## 2 Safety warning

- Anyone working with, on or around this equipment should read this manual. Failure to read, understand, and follow the instructions given in this documentation may result in damage to the unit, injury to operating personnel, and/or poor equipment performance.
- The use of any hazardous materials in this equipment must be monitored by an industrial hygienist, safety officer or other suitably qualified individuals.
- In this manual, important safety-related points will be marked with the following symbols:



### **NOTE**

It is used to direct attention to a specific item.



### **WARNING**

Use caution.

- If the equipment is used in a manner not specified by this manual, the protection provided by this equipment may be impaired.

## 3 Intended purpose/use

Preparing, storing and transferring human embryos. To be used only with the MIRI® TL device.

## 4 About the product

The Esco Medical CultureCoin® is a sterile, single-use culture vessel specifically developed for use in IVF. It consists of two parts: dish and cover. The dish holds up to 14 embryos in the centrally placed line of culture wells. The culture well features a 300µm,

an optically clear area where the embryo is situated. The area is optimized for microscopy. A clear circle is present around the culture area for the purpose of making it easy for an automatic focus algorithm to find the area under microscopic image acquisition. The culture wells are numbered (1 – 14) for easy location of each well by the user. The dish has 4 washing wells for cell manipulations, washing media or replacement media.

A large well is provided outside the culture area for pH measuring without affecting the cultured samples. The dish has a flat bottom, so it is ideal for heat transfer from below. The cover is mounted on top of the dish, covering the whole top area completely. The user will only grab the dish during handling by pinching on the grip-lip features of the dish without the risk of losing the dish by holding on to the cover only – as can be the case on all traditionally designed dishes.

Mode of action: Esco Medical CultureCoin® was designed to ensure a safe and intended environment to help treat patient infertility problems and assist with the conception of a child. Embryo growth in the CultureCoin® is achieved using specific non-toxicity fertility or reproductive function plastic, media that provide a nurturing environment, and the MIRI® TL family's multiroom IVF incubator that creates and keeps stable environment temperature and gases concentration.

Principles of operation of the device: CultureCoin® is designed to culture cells only in Esco Medical Technologies MIRI® TL family's multiroom IVF incubators for a period of up to 6 days. The capacity of droplets in incubation wells is 25µl. Such an amount of media is sufficient for cell development during such a period. A high wall surrounds the droplet area to ensure enough space for an oil overlay to secure media from evaporation. Incubation wells are situated in one line, at the same height and across the exact distance between well centers. It perfectly fits the design of the MIRI® TL family's multiroom IVF incubators, which camera moves under CultureCoin® along incubation wells.

The CultureCoin® dishes are packed individually. The packing box contains 25 dishes.

Model Code: MRI-CC. Ref No: 1821493.

Only individuals with formal education in a relevant field of healthcare or medical discipline could work with CultureCoin® dishes.

Esco Medical CultureCoin® is used for *in vitro* fertilization (IVF) patients. Patients are women in their reproductive years who have fertility health issues. The intended target group indication is IVF treatment. There are no intended target group contraindications.



CultureCoin® is a medical device intended to be used on one patient during a single procedure. It is not intended to be reprocessed (cleaned, disinfected/sterilized) and used on another patient.

CultureCoin® can be used only with the MIRI® TL family’s multiroom IVF incubators and sequential media specifically designed for IVF treatment. CultureCoin® cannot be used with non-medical devices and other non-IVF treatment-designed media.

The device is manufactured under a full EU-certified 13485 ISO quality management system.

This product conforms to the requirements of the Regulation (EU) 2017/745 concerning medical devices and is classified as a Class IIa device under rule II.

Personal Protective Equipment (89/686/EEC) and Machine Directive (2006/42/EC) are not applicable for the CultureCoin®. Also, the CultureCoin® do not contain or incorporate: a medical substance, including a human blood or plasma derivate; tissues or cells, or their derivates, of human origin; or tissues or cells of animal origin, or their derivatives, as referred to in Regulation (EU) NO. 722/2012.

## 5 Safety symbols and labels

There are several user labels on the surfaces of the CultureCoin® to guide the user. User labels are shown below.

**Table 5.1** Packing bag label

Description	Image
<p><b>Packaging bag label:</b></p> <ol style="list-style-type: none"> <li>1. Logo</li> <li>2. Model</li> <li>3. Catalogue number</li> <li>4. Batch code</li> <li>5. Temperature limit</li> <li>6. Rx only</li> <li>7. Consult instructions for use</li> <li>8. Do not use if package is damaged</li> <li>9. Keep away from direct sunlight</li> <li>10. Manufacturer</li> <li>11. UDI code</li> <li>12. CE mark</li> <li>13. Use-by date</li> <li>14. Sterilized using irradiation</li> <li>15. Sterile barrier system</li> <li>16. Keep dry</li> <li>17. Medical device</li> <li>18. WEEE</li> <li>19. Do not resterilize</li> <li>20. Non-pyrogenic</li> <li>21. Do not re-use</li> </ol>	

**Table 5.2** Packing box label

Description	Image
<p><b>Packing box label:</b></p> <ol style="list-style-type: none"> <li>1. Logo</li> <li>2. Model</li> <li>3. Catalogue number</li> <li>4. Batch code</li> <li>5. Consult instructions for use</li> <li>6. Do not use if package is damaged</li> <li>7. Keep away from direct sunlight</li> <li>8. Manufacturer</li> <li>9. UDI code</li> <li>10. CE mark</li> <li>11. Use-by date</li> <li>12. Keep dry</li> <li>13. Temperature limit</li> <li>14. Medical device</li> <li>15. Sterilized using irradiation</li> <li>16. Amount of dishes</li> </ol>	
<p><b>Sterilization indication label</b></p> <p>The medical device cannot be used if the label is not red.</p> <p>Please contact Esco Medical Technologies or the local Representative.</p>	

## 6 Important safety instructions and warnings

### 6.1 Pre-use

1. Do not use the product if the package is damaged. Contact Esco Medical Technologies or the local Representative.
2. Always keep these instructions in a place where they can be easily accessed.

**⚠ With CultureCoin® dishes could work only individuals with formal education in a relevant field of healthcare or medical discipline.**

Basic training on how to use CultureCoin® with MIRI® TL family's multiroom IVF incubators is provided along with the installation of MIRI® TL family's multiroom IVF incubators.

### 6.2 During use

1. Use only for the purpose listed under the intended purpose.
2. The dishes are single-use only. Please do not attempt to clean and reuse them.
3. Only for the use of water-based culture media, mineral or Paraffin oil.

4. Do not use this product in the MIRI® TL family's multiroom IVF incubators at temperatures exceeding 40.0 °C.

Functions related to SAFETY:

- Identifying the correct dish;
- Picking and lifting the dish;
- Avoiding cross-contamination;
- Placing the embryo correctly.

 Please refer to sections 9 – 14 in this manual for more information on properly using CultureCoin®.

### 6.3 Post-use

If the dish was used to store/incubate biological samples, it should be discarded as biohazardous waste according to laws and procedures valid in the user's country.

## 7 The Culture mode

The CultureCoin® can be used only for culturing with culture media filled into the wells and oil overlay. They cannot be used for open culture.

## 8 Overview

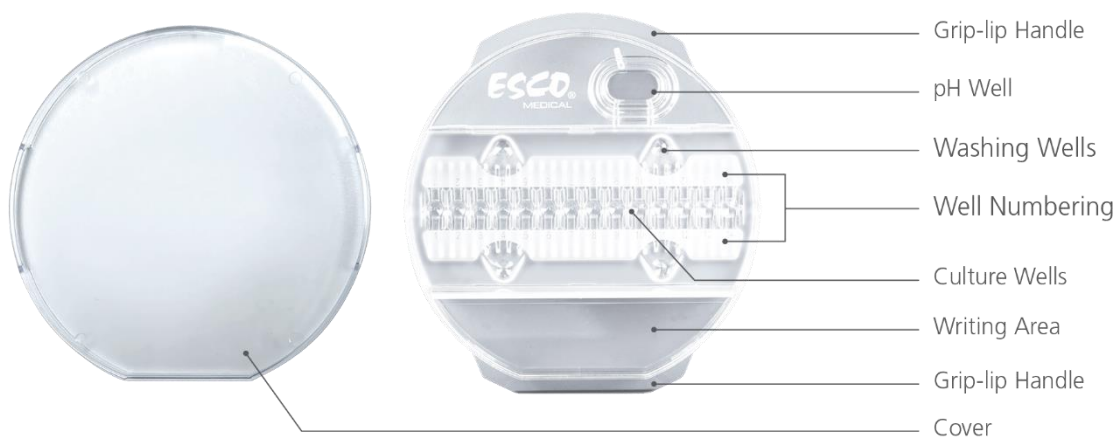

**Figure 8.1** CultureCoin® overview

The CultureCoin® dish consists of 2 parts:

- CultureCoin® dish (1).
- Cover (2) that covers the entire CultureCoin® area.



**Figure 8.2** CultureCoin® dish parts

## 9 Use

1. Unpack both the cover and dish in an aseptic environment.
2. Leave the dishes with the covers on for off-gassing in the aseptic environment for 12 hours (overnight).
3. Warm the dishes on a heated stage or an incubator before filling them with media.
4. Fill all the culture wells with approximately 25  $\mu$ l of precultured equilibrated culture media in an aseptic environment.
5. Filling of the washing wells is optional. One washing well contain approximately 23  $\mu$ l. They can be used for cell manipulations, washing media or replacement media.
6. Check under a microscope for any visible air bubbles and remove them with a stripper tip.
7. Fill the oil area with a confluent layer of suitable mineral or Paraffin oil to cover the culture media. The recommended amount is 6 ml. Do not overfill.
8. Put the cover on the dish and leave it for 4 hours of equilibration in the CO<sub>2</sub> incubator (humidified incubator is preferable).
9. Check for air bubbles in the culture wells after the equilibration. Remove any bubbles with a stripper tip.
10. Load the embryos in the culture wells. Make sure the embryos are located very precisely in the center of the culturing well and not on the side slope.
11. Optionally fill the pH well with culture media up to the lowest step (recommended volume – 350  $\mu$ l) of the pH well and cover it with an oil overlay (recommended volume – 150  $\mu$ l).
12. Put on the CultureCoin® cover.
13. Put the CultureCoin® in the MIRI® TL family's multiroom IVF incubator as instructed in the 10<sup>th</sup> section below.

## 10 CultureCoin® placement in the chamber

Before starting the time-lapse, correctly placing the CultureCoin® in the chamber is essential. To ensure the correct position of the CultureCoin® (so that the camera can identify all the culture wells), place the CultureCoin® in its place and secure its position by pushing it **downwards and towards you**, then to the **left edge**.

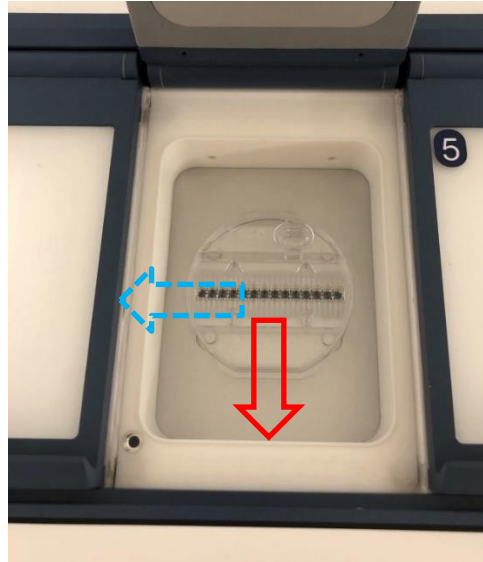

Figure 10.1 Positioning CultureCoin® in the compartment

## 11 Removing the CultureCoin® cover

CultureCoin® cover does not have a lot of free movement on the dish while it is closed, but the cover may move slightly during transportation. The cover can rotate a bit on the CultureCoin® and get stuck on the dish edges. As a result, it may be harder to open it.

There is a specific technique for the CultureCoin® cover opening in such a case. **Hold the dish on the grip-lip** and **lift the cover from the cut edge**.

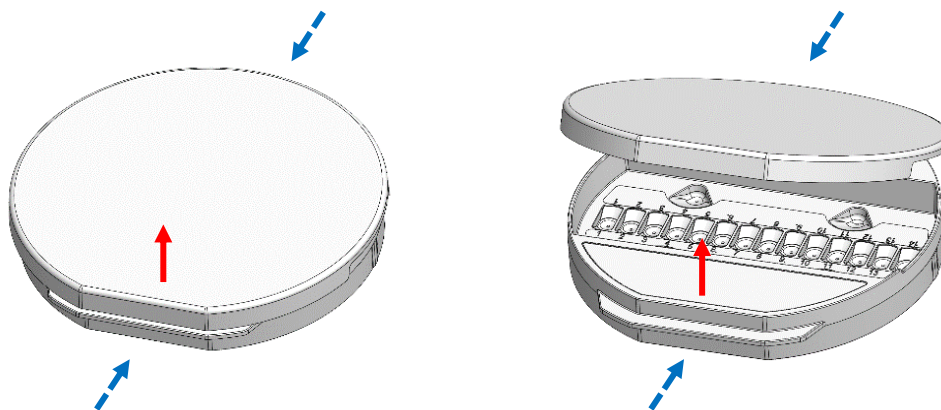
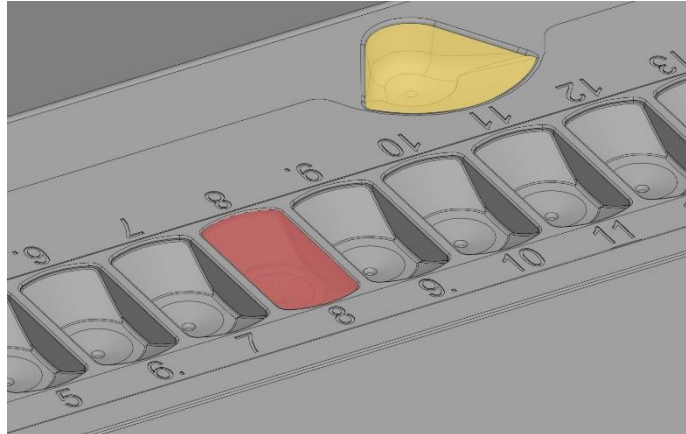

Figure 11.1 CultureCoin® cover opening

 Please do not twist the cover of the CultureCoin®, because it will be locked, and it will be even harder to open it.

## 12 The use illustrated



**Figure 12.1** The culture well (marked red) and washing well (marked yellow)

Each of the 14 culture wells is filled with approximately 25  $\mu\text{l}$  culture medium. The embryo is placed at the bottom of the culturing area, as shown in Figure 12.2.

The washing wells can also be filled with 23  $\mu\text{l}$  of culture media, but it is not a requirement.

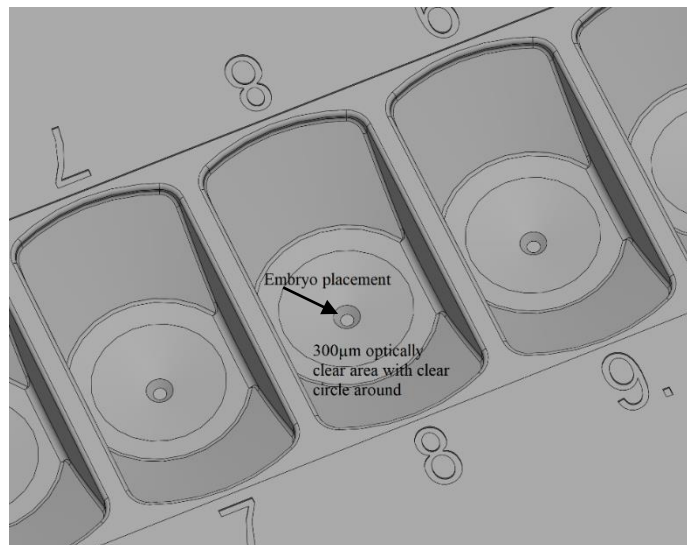

**Figure 12.2** Embryo Placement in detail on the 300 $\mu\text{m}$  optically clear area

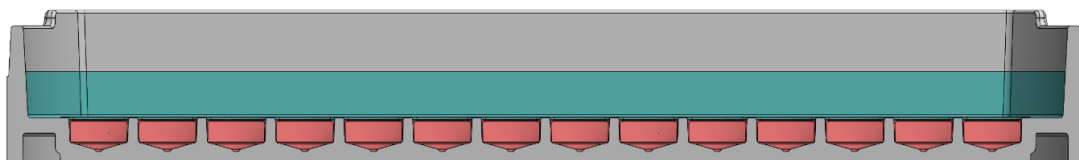

**Figure 12.3** The culture wells are covered with a mineral or Paraffin oil layer and the cover is put on

The culture media is filled into the culture wells (marked red), then oil (marked blue-green) is added to cover the entire cultivation area.

## 13 pH measuring

Validating the pH of the culture media should be a standard procedure. The CultureCoin® has a large well outside the culturing area (Figure 8.1). It makes it possible to make spot checks safely and conveniently on the pH level without disturbing culture wells.

The pH is measured using this procedure:

1. Calibrate the pH electrode following the “User manual of MIRI® TL family’s multiroom IVF incubators”, section 18.
2. Remove the oil overlay from the pH well.
3. Insert the pH electrode, inspect that the electrode sensor is fully covered with the culture media.
4. Measure pH in the culture media.
5. If pH will be measured after some time again, do not forget to fill an oil overlay under the culture media (recommended volume – 150 µl).
6. Repeat the pH measurement procedure from Point 1.

Adjust the CO<sub>2</sub> level if necessary.

When choosing a pH electrode, it is necessary to consider the probe's size. Esco Medical Technologies recommends using a 3 mm diameter probe size.

## 14 Writing area on the CultureCoin® and lid

There is a dedicated area where the user can write or put a label with patient data on the CultureCoin® dish area marked red in Figure 14.1 below.

Only use special markers that do not release volatile organic compounds (VOCs).



**Figure 14.1** Always mark both the lid and the dish

## 15 User troubleshooting

**Table 15.1** General issues

Symptom	Cause	Action
Embryos drift to the side of the well.	The placement of the embryo is not done with enough accuracy.	Practice correct placement.
Air bubbles appear during culturing.	Temperature differences during loading or incorrect procedure for bubble removal.	Avoid temperature differences and follow the correct procedure. Practice proper bubble removal.
	Unequilibrated media is used.	Use equilibrated media.
Oil overflows during the handling of the dish.	Too much oil is used for oil overlay under culture wells.	Decrease the oil volume.

## 16 Specifications

**Table 16.1** CultureCoin® specifications

Technical specifications	CultureCoin®
Overall dimensions (Diameter x Height)	Ø 71 × 10 mm
CultureCoin® weight in total	13.8 grams
Material	Styrene Methyl Methacrylate (SMMA)
Incubation temperature range	28.7 – 40.0 °C
Incubation CO <sub>2</sub> range	1.9 – 10.0%
Incubation O <sub>2</sub> range	4.9 – 20.0%
Sterilization method	Gamma irradiation
Lifetime	2 years
Biocompatibility tests	<ol style="list-style-type: none"> <li>1. Mouse Embryo Assay (MEA) test with thawed 1-cell mouse embryos. Acceptance criteria: at least 80% of embryos developed to the blastocyst stage.</li> <li>2. Limulus Amebocyte Lysate (LAL) test. Acceptance criteria: &lt; 20 EU/device.</li> </ol>



## 17 Other countries

### 17.1 Switzerland

The Swiss Authorised Representative CH-REP symbol is placed on each selling unit (packing box).



**Figure 17.1** Swiss Authorised Representative

Swiss Authorised Representative's contact e-mail is “[Vigilance@medenvoyglobal.com](mailto:Vigilance@medenvoyglobal.com)”.

## 18 Reporting on serious incidents

In case of any serious incidents that have occurred in relation to the device should be reported to Esco Medical Technologies, UAB, by contacts, written on the contact information page, and the Authorised Representative in which the user and/or patient is established.

For contacting Authorised Representative, please refer to the “Other countries” section according to your country.